



Modular conveyor oven

T64E, the electric modular conveyor oven, is composed of one or more **stackable baking chambers** and an optional stand. During baking, the product is placed on the conveyor belt and passes through two flows of hot air: **impingement technology**, the best system for heat distribution in the whole baking chamber for **perfect baking of pizza, pastry, bakery, and gastronomy**. Management of needed power is automatic according to the load. The power control of ceiling and floor is independent and managed by two probes. The conveyor speed is adjustable. Efficiently insulated and isolated, the external surfaces are cool even during use. Installable as countertop or on an optional stand closed by stainless steel doors on swivel castors. The baking chamber maximum temperature is 320°C (608°F).



OPERATION

- Heated by armoured heating elements
- Control of power PID (Proportional Supplementary Derivative) can allow the automatic regulation of energy necessary on the basis of the quantity of the batch product **ADAPTIVE-POWER® TECHNOLOGY**
- Independent adjustment and control of ceiling and floor, with continuous temperature detection using 2 high sensitive thermocouples **DUAL-TEMP® TECHNOLOGY**
- Air blowing system using stainless steel fan
- Conveyor belt with speed adjustable from 30" to 20 minutes and feed-back control at the option of belt standstill
- Programmable electronic function management **ECO-SMARTBAKING®**
- Maximum temperature reached 320°C (608°F)
- Independent system for additional forced air cooling of the components with low noise

CONSTRUCTION

- Structure in folded stainless steel sheets
- Stainless steel door hinged on left hand side with logo **BlackBar® Design**
- Extractable stainless steel conveyor belt, with continuous tensioning
- Electronic control panel on front left side
- Adjustable feet
- Baking chamber in stainless steel sheets
- Top and bottom blowers in welded stainless steel sheets, extractable for cleaning
- Rock wool heat insulation, thermal minijoints and air space **COOL AROUND® Technology**

ACCESSORIES

- Stand with castors, height 137, 600mm
- Loading or unloading roller
- Harvest bread basket
- Hood for vapour extraction
- Remote-Master® Technology
- Ventless Option (EPA Test Method 202), maximum 2 cooking chambers
Ventless certification is for food items except for foods classified as "fatty raw proteins". Ultimate ventless allowance is dependent upon AHJ approval, as some jurisdictions may not recognize the UL certification or application.

BAKING DIMENSIONS

Belt width L	406mm
Internal length	510mm
Total length P	1234mm
Total length P with pizza rest	1484mm
Tot. baking surface	0,2m ²

STANDARD EQUIPMENT

- 4 displays
- 20 customisable programs
- **ECO-STAND BY™ TECHNOLOGY** Saving device with the possibility to stop the belt for break
- Discontinuous baking cycle **STEP**
- Double pass baking cycle **RETURN**
- **LOCK** function
- Auto test with display of error message
- Independent maximum temperature safety device
- Stainless steel resting support (+250mm)
- SmartBaking app
- Wifi module for sw update

TOP VIEW

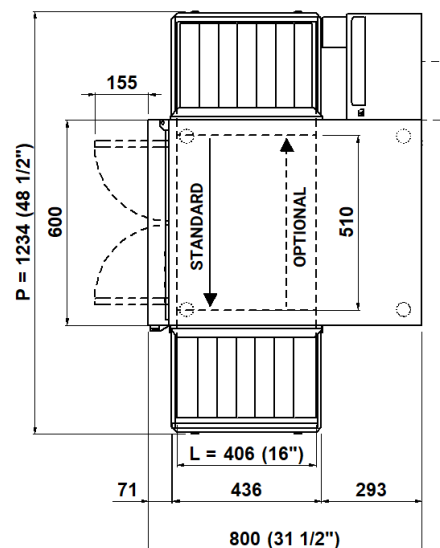

2 baking chambers

(assembled with stand height 600mm)

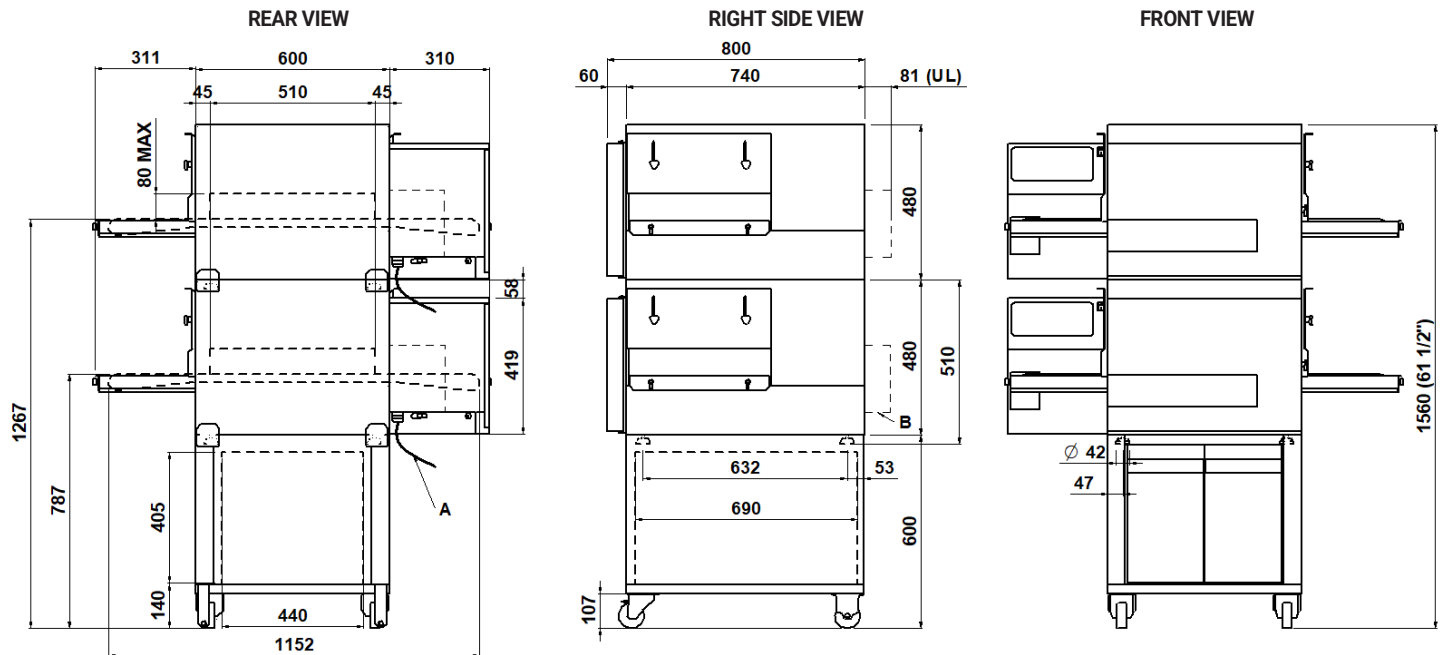

NOTE: The dimensions indicated in the views are in millimeters.

A Electrical cable length 4 meters	B Only for UL model fairleads		
---	--	--	--

DIMENSIONS

External height	1560mm
External depth	800mm
External width	1234mm
Weight (excl. stand)	186kg

SHIPPING INFORMATION

Packed oven (each packed deck)	2x655mm
Height	920mm
Depth	1380mm
Weight	(186+30)kg

FEEDING AND POWER

Standard feeding	A.C. V400 3N
Feeding on request	A.C. V230 3 V230 1N
Frequency	50/60Hz

TOTAL BAKING CAPACITY

*N° Pizzas /hour	N°50
Pizzas diameter 330mm	

Packaged stand dimensions:	
Height	600mm
Depth	650mm
Width	790mm
Weight	(18+5)kg

Max power	13,8kW
*Medium cons/hour	7kWh
Connecting cable for each chamber	type H07RN-F
	5x2,5mm ² (V400 3N)
	4x4 mm ² (V230 3)
	3x6mm ² (V230 1N)

* This value is subject to variation according to the way in which the equipment is used

NOTE: MORETTI FORNI S.P.A. reserves the right to modify the characteristics of the products illustrated in this publication without prior notice

3 baking chambers
(assembled with stand height 137mm)

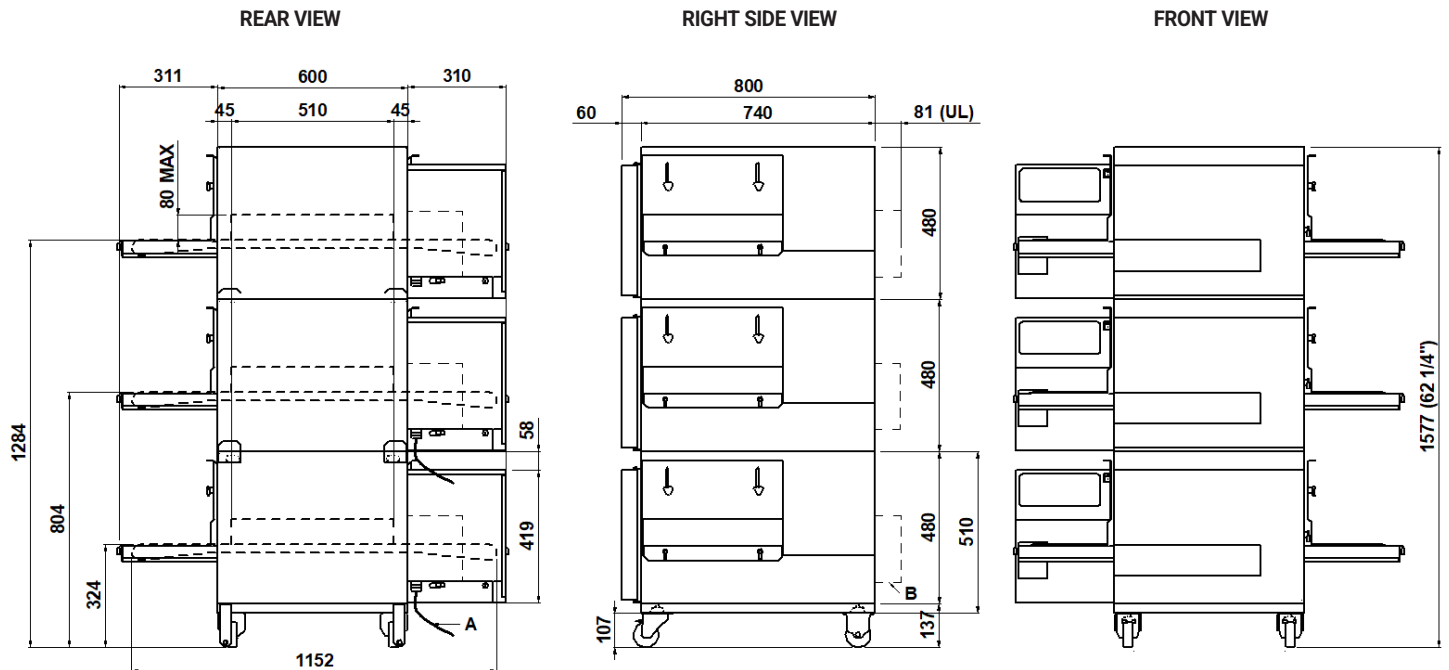

NOTE: The dimensions indicated in the views are in millimeters.

A Electrical cable length 4 meters	B Only for UL model fairleads		
--	---	--	--

DIMENSIONS

External height.	1577mm
External depth	800mm
External width	1234mm
Weight(excl.stand)	279kg

TOTAL BAKING CAPACITY

*N° Pizzas /hour	N°75
Pizzas diameter 330mm	

SHIPPING INFORMATION

Packed oven (each packed deck)	3x655mm
Height	920mm
Depth	1380mm
Width	(279+45)kg
Weight	

Packaged stand dimensions:

Height	200mm
Depth	630mm
Width	800mm
Weight	(15+3)kg

FEEDING AND POWER

Standard feeding	A.C. V400 3N
Feeding on request	A.C. V230 3 V230 1N
Frequency	50/60Hz
Max power	20,7kW
*Medium cons/hour	10,5kWh
Connecting cable for each chamber	type H07RN-F
	5x2,5mm ² (V400 3N)
	4x4 mm ² (V230 3)
	3x6mm ² (V230 1N)

* This value is subject to variation according to the way in which the equipment is used
NOTE: MORETTI FORNI S.P.A. reserves the right to modify the characteristics of the products illustrated in this publication without prior notice

TECHNICAL DATA

ONLY FOR UL MODEL

Ventless Option

EPA Test Method 202: (8hr)P roduct Pepperoni Pizza, Ventless Requirement: not exceed 5.00mg/m3 Internal catalytic filtration to limit emissions

<p>FEEDING AND POWER (EACH DECK NEEDS TO BE CONNECTED INDEPENDENTLY AND THE LOAD SHOWN BELOW ARE PER DECK)</p>	A.C. V240 3ph 60Hz	Standard feeding	Max power	kW	6,9
			*Medium cons/hour	kWh	3,5
			Ampère Max	A	16,6
			Connecting cable	AWG/DECK	12
	A.C. V208 3ph 60Hz	Feeding on request	Max power	kW	6,9
			*Medium cons/hour	kWh	3,5
			Ampère Max	A	19,0
			Connecting cable	AWG/DECK	12
	A.C. V240 1ph 60Hz	Feeding on request	Max power	kW	6,9
			*Medium cons/hour	kWh	3,5
			Ampère Max	A	28,5
			Connecting cable	AWG/DECK	8,0
	A.C. V208 1ph 60Hz	Feeding on request	Max power	kW	6,9
			*Medium cons/hour	kWh	3,5
			Ampère Max	A	32,8
			Connecting cable	AWG/DECK	8

* This value is subject to variation according to the way in which the equipment is used

NOTE: MORETTI FORNI S.P.A. reserves the right to modify the characteristics of the products illustrated in this publication without prior notice



Modular conveyor oven

T64E, the electric modular conveyor oven, is composed of one or more **stackable baking chambers** and an optional stand. During baking, the product is placed on the conveyor belt and passes through two flows of hot air: **impingement technology**, the best system for heat distribution in the whole baking chamber for **perfect baking of pizza, pastry, bakery, and gastronomy**. Management of needed power is automatic according to the load. The power control of ceiling and floor is independent and managed by two probes. The conveyor speed is adjustable. Efficiently insulated and isolated, the external surfaces are cool even during use. Installable as countertop or on an optional stand closed by stainless steel doors on swivel castors. The baking chamber maximum temperature is 320°C (608°F).



OPERATION

- Heated by armoured heating elements
- Control of power PID (Proportional Supplementary Derivative) can allow the automatic regulation of energy necessary on the basis of the quantity of the batch product **ADAPTIVE-POWER® TECHNOLOGY**
- Independent adjustment and control of ceiling and floor, with continuous temperature detection using 2 high sensitive thermocouples **DUAL-TEMP® TECHNOLOGY**
- Air blowing system using stainless steel fan
- Conveyor belt with speed adjustable from 30" to 20 minutes and feed-back control at the option of belt standstill
- Programmable electronic function management **ECO-SMARTBAKING®**
- Maximum temperature reached 320°C (608°F)
- Independent system for additional forced air cooling of the components with low noise

CONSTRUCTION

- Structure in folded stainless steel sheets
- Stainless steel door hinged on left hand side with logo **BlackBar® Design**
- Extractable stainless steel conveyor belt, with continuous tensioning
- Electronic control panel on front left side
- Adjustable feet
- Baking chamber in stainless steel sheets
- Top and bottom blowers in welded stainless steel sheets, extractable for cleaning
- Rock wool heat insulation, thermal minijoints and air space **COOL AROUND® Technology**

ACCESSORIES

- Stand with castors, height 137, 600mm
- Loading or unloading roller
- Harvest bread basket
- Hood for vapour extraction
- Remote-Master® Technology
- Ventless Option (EPA Test Method 202), maximum 2 cooking chambers
Ventless certification is for food items except for foods classified as "fatty raw proteins". Ultimate ventless allowance is dependent upon AHJ approval, as some jurisdictions may not recognize the UL certification or application.

BAKING DIMENSIONS

Belt width L	406mm
Internal length	510mm
Total length P	1234mm
Total length P with pizza rest	1484mm
Tot. baking surface	0,2m ²

STANDARD EQUIPMENT

- 4 displays
- 20 customisable programs
- **ECO-STAND BY™ TECHNOLOGY** Saving device with the possibility to stop the belt for break
- Discontinuous baking cycle **STEP**
- Double pass baking cycle **RETURN**
- **LOCK** function
- Auto test with display of error message
- Independent maximum temperature safety device
- Stainless steel resting support (+250mm)
- SmartBaking app
- Wifi module for sw update

TOP VIEW

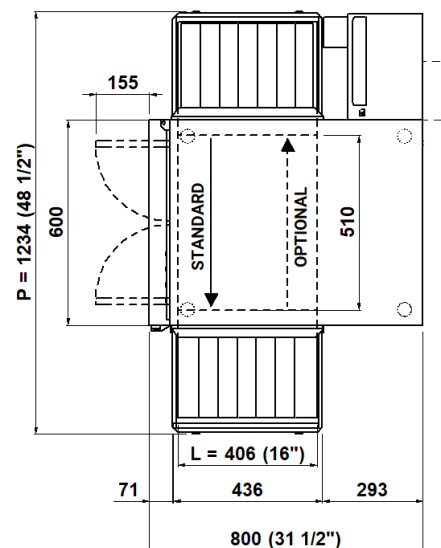

1 baking chamber
(assembled with stand height 600mm)

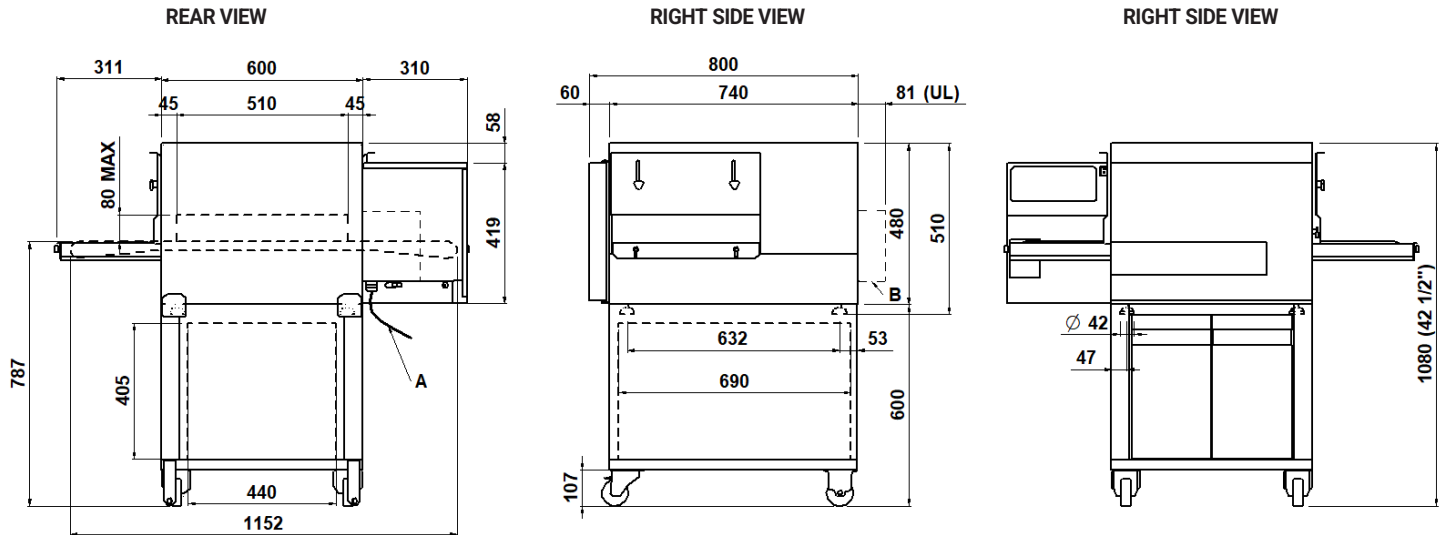

NOTE: The dimensions indicated in the views are in millimeters.

A	B		
Electrical cable length 4 meters	Only for UL model fairlead		

DIMENSIONS

External height	1080mm
External depth.	800mm
External width.	1234mm
Weight (excl. stand)	93kg

TOTAL BAKING CAPACITY

*N° Pizzas /hour	N°25
Pizzas diameter 330mm	

SHIPPING INFORMATION

Dimensions of packed oven	
Height	655mm
Depth	920mm
Width	1380mm
Weight	(93+15)kg

Packaged stand dimensions:

Height	600mm
Depth	650mm
Width	790mm
Weight	(18+5)kg

FEEDING AND POWER

Standard feeding	
A.C. V400 3N	
Feeding on request	
A.C. V230 3 V230 1N	
Frequency	50/60Hz

Max power	6,9kW
*Medium cons/hour	3,5kWh
Connecting cable for each chamber	
type H07RN-F	
5x2,5mm ² (V400 3N)	
4x4 mm ² (V230 3)	
3x6mm ² (V230 1N)	

* This value is subject to variation according to the way in which the equipment is used

NOTE: MORETTI FORNI S.P.A. reserves the right to modify the characteristics of the products illustrated in this publication without prior notice

2 baking chambers

(assembled with stand height 600mm)

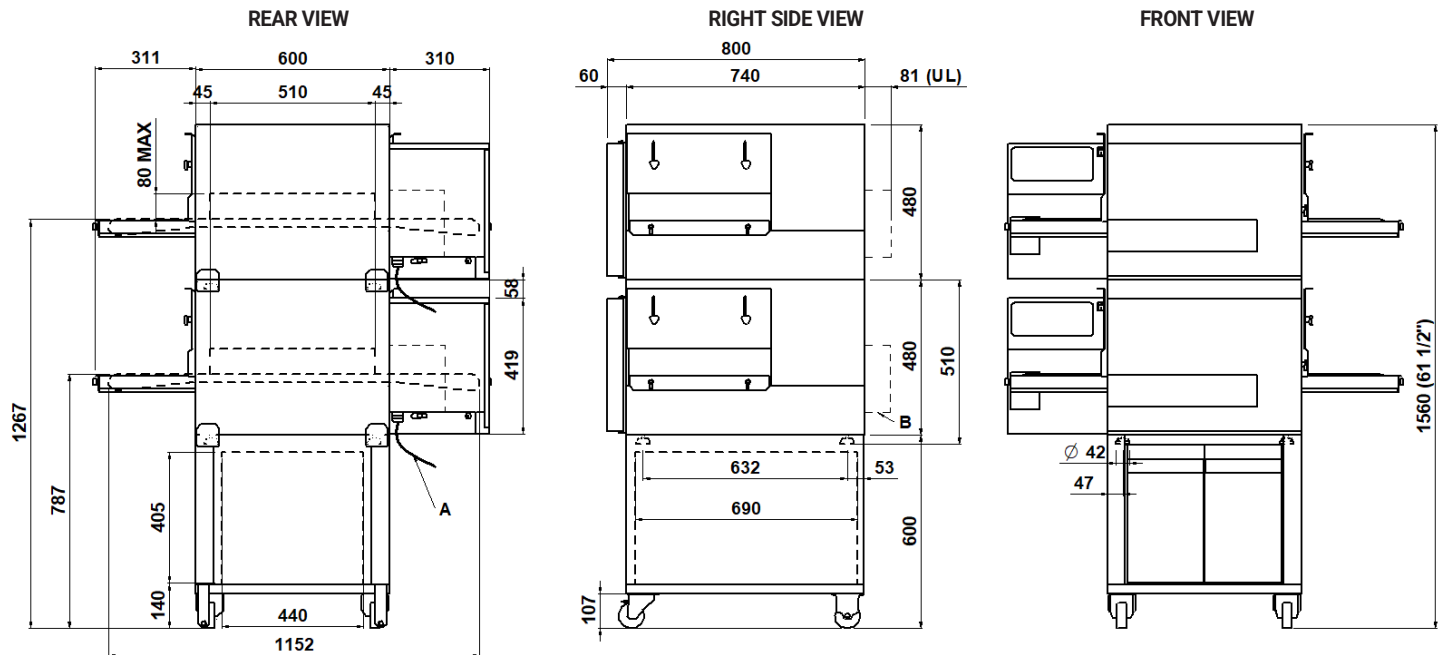

NOTE: The dimensions indicated in the views are in millimeters.

A Electrical cable length 4 meters	B Only for UL model fairleads		
---	--	--	--

DIMENSIONS

External height	1560mm
External depth	800mm
External width	1234mm
Weight (excl. stand)	186kg

TOTAL BAKING CAPACITY

*N° Pizzas /hour	N°50
Pizzas diameter 330mm	

SHIPPING INFORMATION

Packed oven (each packed deck)	2x655mm
Height	920mm
Depth	1380mm
Weight	(186+30)kg

Packaged stand dimensions:	
Height	600mm
Depth	650mm
Width	790mm
Weight	(18+5)kg

FEEDING AND POWER

Standard feeding	A.C. V400 3N
Feeding on request	A.C. V230 3 V230 1N
Frequency	50/60Hz

Max power	13,8kW
*Medium cons/hour	7kWh
Connecting cable for each chamber	type H07RN-F
	5x2,5mm ² (V400 3N)
	4x4 mm ² (V230 3)
	3x6mm ² (V230 1N)

* This value is subject to variation according to the way in which the equipment is used

NOTE: MORETTI FORNI S.P.A. reserves the right to modify the characteristics of the products illustrated in this publication without prior notice

3 baking chambers
(assembled with stand height 137mm)

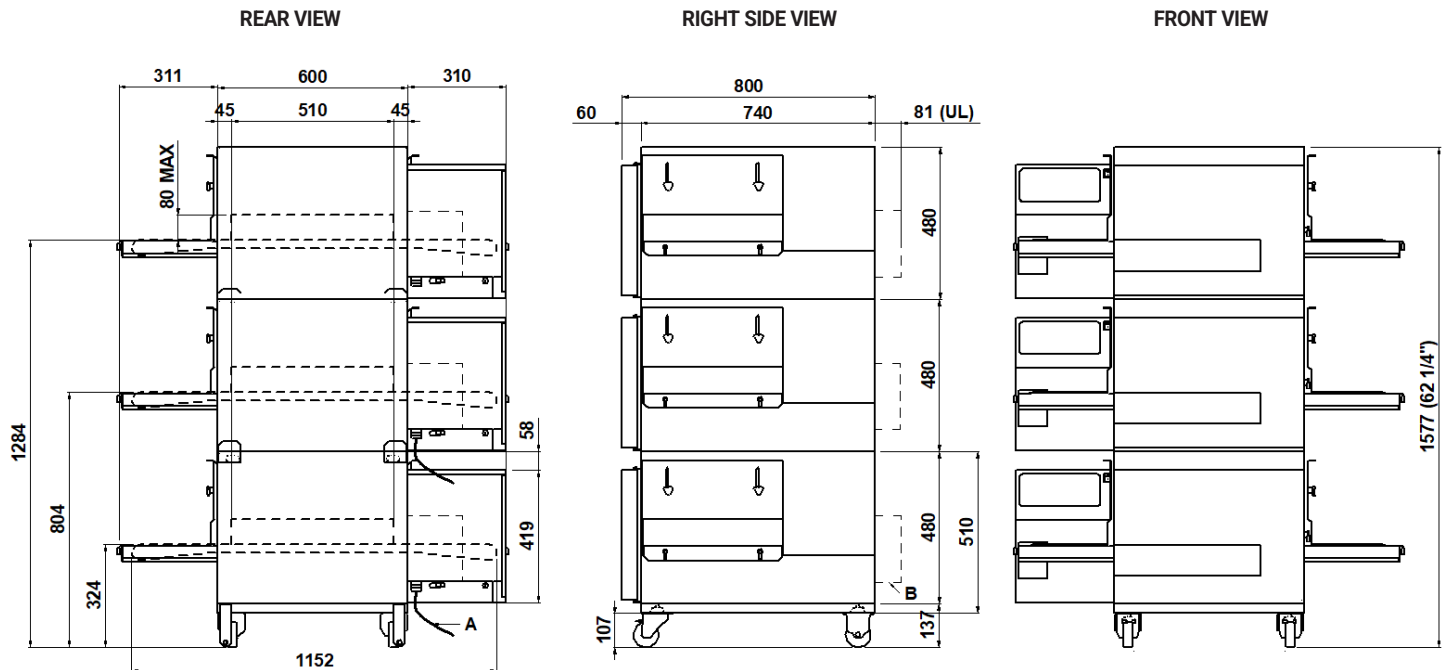

NOTE: The dimensions indicated in the views are in millimeters.

A Electrical cable length 4 meters	B Only for UL model fairleads		
---	--	--	--

DIMENSIONS

External height.	1577mm
External depth	800mm
External width	1234mm
Weight(excl.stand)	279kg

TOTAL BAKING CAPACITY

*N° Pizzas /hour	N°75
Pizzas diameter 330mm	

SHIPPING INFORMATION

Packed oven (each packed deck)	3x655mm
Height	920mm
Depth	1380mm
Weight	(279+45)kg

Packaged stand dimensions:

Height	200mm
Depth	630mm
Width	800mm
Weight	(15+3)kg

FEEDING AND POWER

Standard feeding	A.C. V400 3N
Feeding on request	A.C. V230 3 V230 1N
Frequency	50/60Hz
Max power	20,7kW
*Medium cons/hour	10,5kWh
Connecting cable for each chamber	type H07RN-F
	5x2,5mm ² (V400 3N)
	4x4 mm ² (V230 3)
	3x6mm ² (V230 1N)

* This value is subject to variation according to the way in which the equipment is used

NOTE: MORETTI FORNI S.P.A. reserves the right to modify the characteristics of the products illustrated in this publication without prior notice

TECHNICAL DATA

ONLY FOR UL MODEL

Ventless Option

EPA Test Method 202: (8hr)P roduct Pepperoni Pizza, Ventless Requirement: not exceed 5.00mg/m3 Internal catalytic filtration to limit emissions

<p>FEEDING AND POWER (EACH DECK NEEDS TO BE CONNECTED INDEPENDENTLY AND THE LOAD SHOWN BELOW ARE PER DECK)</p>	A.C. V240 3ph 60Hz	Standard feeding	Max power	kW	6,9
			*Medium cons/hour	kWh	3,5
			Ampère Max	A	16,6
			Connecting cable	AWG/DECK	12
	A.C. V208 3ph 60Hz	Feeding on request	Max power	kW	6,9
			*Medium cons/hour	kWh	3,5
			Ampère Max	A	19,0
			Connecting cable	AWG/DECK	12
	A.C. V240 1ph 60Hz	Feeding on request	Max power	kW	6,9
			*Medium cons/hour	kWh	3,5
			Ampère Max	A	28,5
			Connecting cable	AWG/DECK	8,0
	A.C. V208 1ph 60Hz	Feeding on request	Max power	kW	6,9
			*Medium cons/hour	kWh	3,5
			Ampère Max	A	32,8
			Connecting cable	AWG/DECK	8

* This value is subject to variation according to the way in which the equipment is used

NOTE: MORETTI FORNI S.P.A. reserves the right to modify the characteristics of the products illustrated in this publication without prior notice



Modular conveyor oven

T64E, the electric modular conveyor oven, is composed of one or more **stackable baking chambers** and an optional stand. During baking, the product is placed on the conveyor belt and passes through two flows of hot air: **impingement technology**, the best system for heat distribution in the whole baking chamber for **perfect baking of pizza, pastry, bakery, and gastronomy**. Management of needed power is automatic according to the load. The power control of ceiling and floor is independent and managed by two probes. The conveyor speed is adjustable. Efficiently insulated and isolated, the external surfaces are cool even during use. Installable as countertop or on an optional stand closed by stainless steel doors on swivel castors. The baking chamber maximum temperature is 320°C (608°F).



OPERATION

- Heated by armoured heating elements
- Control of power PID (Proportional Supplementary Derivative) can allow the automatic regulation of energy necessary on the basis of the quantity of the batch product **ADAPTIVE-POWER® TECHNOLOGY**
- Independent adjustment and control of ceiling and floor, with continuous temperature detection using 2 high sensitive thermocouples **DUAL-TEMP® TECHNOLOGY**
- Air blowing system using stainless steel fan
- Conveyor belt with speed adjustable from 30" to 20 minutes and feed-back control at the option of belt standstill
- Programmable electronic function management **ECO-SMARTBAKING®**
- Maximum temperature reached 320°C (608°F)
- Independent system for additional forced air cooling of the components with low noise

CONSTRUCTION

- Structure in folded stainless steel sheets
- Stainless steel door hinged on left hand side with logo **BlackBar® Design**
- Extractable stainless steel conveyor belt, with continuous tensioning
- Electronic control panel on front left side
- Adjustable feet
- Baking chamber in stainless steel sheets
- Top and bottom blowers in welded stainless steel sheets, extractable for cleaning
- Rock wool heat insulation, thermal minijoints and air space **COOL AROUND® Technology**

ACCESSORIES

- Stand with castors, height 137, 600mm
- Loading or unloading roller
- Harvest bread basket
- Hood for vapour extraction
- Remote-Master® Technology
- Ventless Option (EPA Test Method 202), maximum 2 cooking chambers
Ventless certification is for food items except for foods classified as "fatty raw proteins". Ultimate ventless allowance is dependent upon AHJ approval, as some jurisdictions may not recognize the UL certification or application.

BAKING DIMENSIONS

Belt width L	406mm
Internal length	510mm
Total length P	1234mm
Total length P with pizza rest	1484mm
Tot. baking surface	0,2m ²

STANDARD EQUIPMENT

- 4 displays
- 20 customisable programs
- **ECO-STAND BY™ TECHNOLOGY** Saving device with the possibility to stop the belt for break
- Discontinuous baking cycle **STEP**
- Double pass baking cycle **RETURN**
- **LOCK** function
- Auto test with display of error message
- Independent maximum temperature safety device
- Stainless steel resting support (+250mm)
- SmartBaking app
- Wifi module for sw update

TOP VIEW

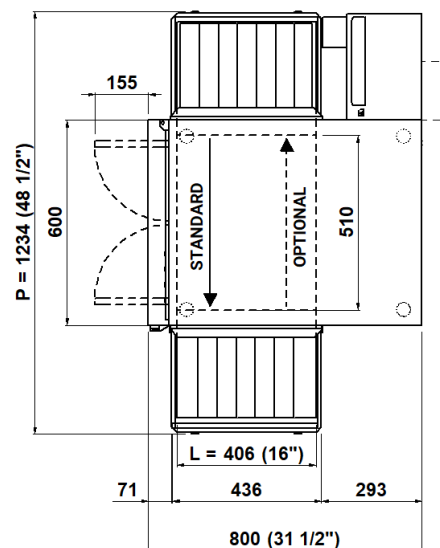

2 baking chambers
(assembled with stand height 600mm)

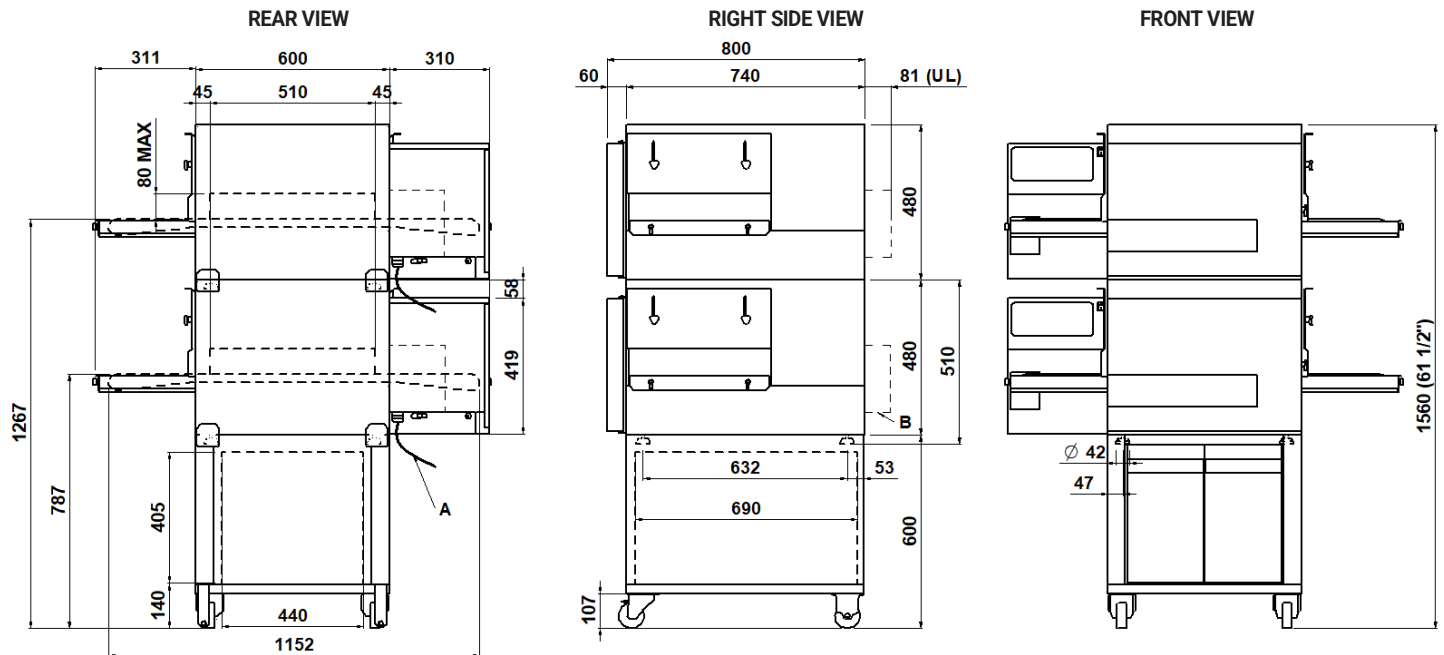

NOTE: The dimensions indicated in the views are in millimeters.

A Electrical cable length 4 meters	B Only for UL model fairleads		
---	--	--	--

DIMENSIONS

External height	1560mm
External depth	800mm
External width	1234mm
Weight (excl. stand)	186kg

SHIPPING INFORMATION

Packed oven (each packed deck)	2x655mm
Height	920mm
Depth	1380mm
Weight	(186+30)kg

FEEDING AND POWER

Standard feeding	A.C. V400 3N
Feeding on request	A.C. V230 3 V230 1N
Frequency	50/60Hz

TOTAL BAKING CAPACITY

*N° Pizzas /hour	N°50
Pizzas diameter 330mm	

Packaged stand dimensions:	
Height	600mm
Depth	650mm
Width	790mm
Weight	(18+5)kg

Max power	13,8kW
*Medium cons/hour	7kWh
Connecting cable for each chamber	type H07RN-F
	5x2,5mm ² (V400 3N)
	4x4 mm ² (V230 3)
	3x6mm ² (V230 1N)

* This value is subject to variation according to the way in which the equipment is used

NOTE: MORETTI FORNI S.P.A. reserves the right to modify the characteristics of the products illustrated in this publication without prior notice

3 baking chambers
(assembled with stand height 137mm)

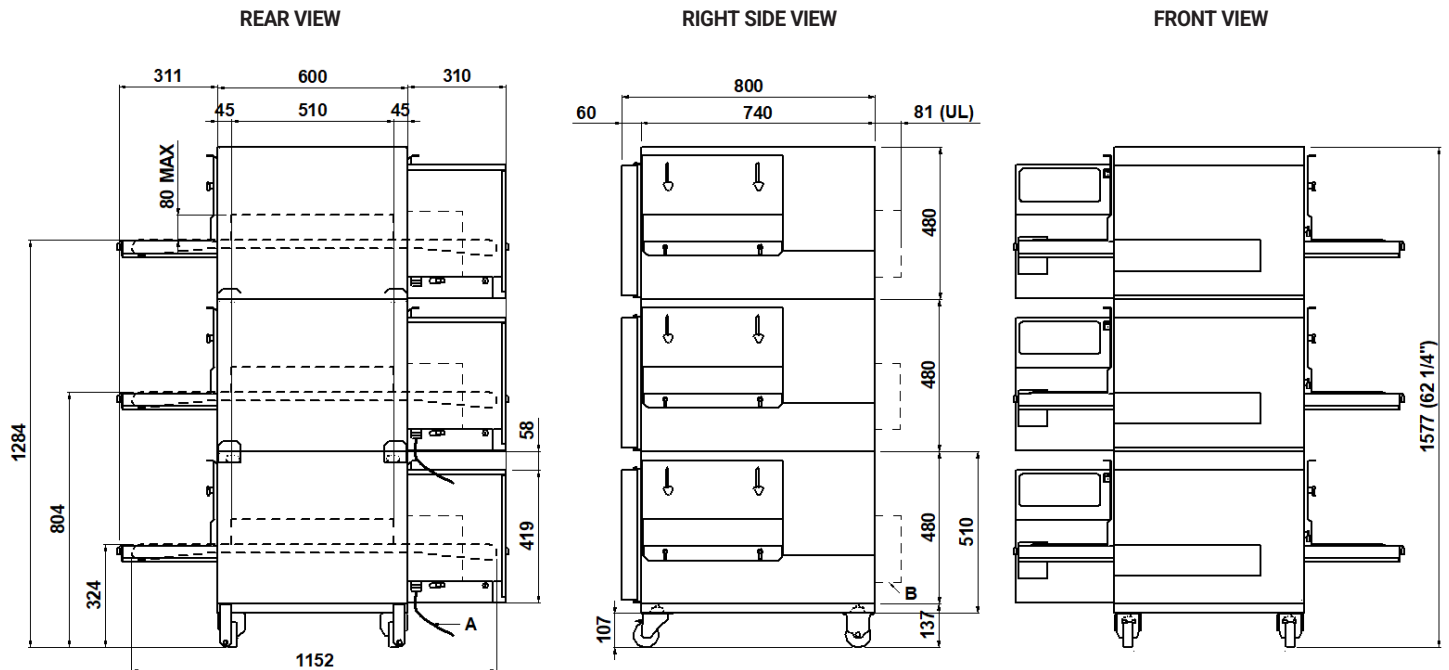

NOTE: The dimensions indicated in the views are in millimeters.

A Electrical cable length 4 meters	B Only for UL model fairleads		
--	---	--	--

DIMENSIONS

External height.	1577mm
External depth	800mm
External width	1234mm
Weight(excl.stand)	279kg

TOTAL BAKING CAPACITY

*N° Pizzas /hour	N°75
Pizzas diameter 330mm	

SHIPPING INFORMATION

Packed oven (each packed deck)	3x655mm
Height	920mm
Depth	1380mm
Weight	(279+45)kg

Packaged stand dimensions:

Height	200mm
Depth	630mm
Width	800mm
Weight	(15+3)kg

FEEDING AND POWER

Standard feeding	A.C. V400 3N
Feeding on request	A.C. V230 3 V230 1N
Frequency	50/60Hz
Max power	20,7kW
*Medium cons/hour	10,5kWh
Connecting cable for each chamber	type H07RN-F
	5x2,5mm ² (V400 3N)
	4x4 mm ² (V230 3)
	3x6mm ² (V230 1N)

* This value is subject to variation according to the way in which the equipment is used

NOTE: MORETTI FORNI S.P.A. reserves the right to modify the characteristics of the products illustrated in this publication without prior notice

TECHNICAL DATA

ONLY FOR UL MODEL

Ventless Option

EPA Test Method 202: (8hr)P roduct Pepperoni Pizza, Ventless Requirement: not exceed 5.00mg/m3 Internal catalytic filtration to limit emissions

<p>FEEDING AND POWER (EACH DECK NEEDS TO BE CONNECTED INDEPENDENTLY AND THE LOAD SHOWN BELOW ARE PER DECK)</p>	A.C. V240 3ph 60Hz	Standard feeding	Max power	kW	6,9
			*Medium cons/hour	kWh	3,5
			Ampère Max	A	16,6
			Connecting cable	AWG/DECK	12
	A.C. V208 3ph 60Hz	Feeding on request	Max power	kW	6,9
			*Medium cons/hour	kWh	3,5
			Ampère Max	A	19,0
			Connecting cable	AWG/DECK	12
	A.C. V240 1ph 60Hz	Feeding on request	Max power	kW	6,9
			*Medium cons/hour	kWh	3,5
			Ampère Max	A	28,5
			Connecting cable	AWG/DECK	8,0
	A.C. V208 1ph 60Hz	Feeding on request	Max power	kW	6,9
			*Medium cons/hour	kWh	3,5
			Ampère Max	A	32,8
			Connecting cable	AWG/DECK	8

* This value is subject to variation according to the way in which the equipment is used

NOTE: MORETTI FORNI S.P.A. reserves the right to modify the characteristics of the products illustrated in this publication without prior notice